

# ***A MESH FAIRY TALE***

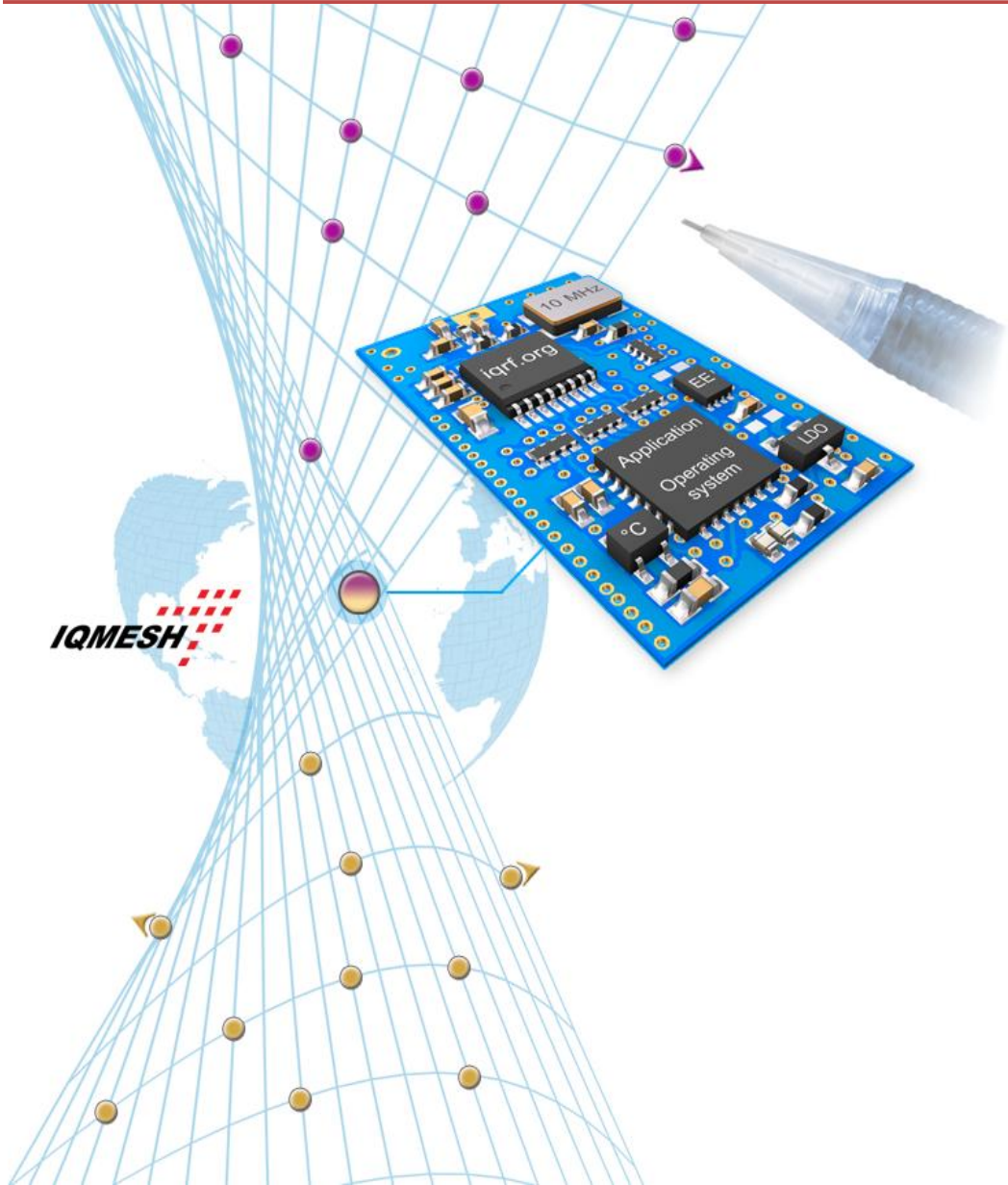

## **The Eighths International Conference on Networking and Services**

**ICNS 2012**

March 26, 2012, St.Marteen

**Vladimír Šulc**  
MICRORISC s.r.o.  
Jičín, Czech Republic  
sulc@microrisc.com



## **Introduction**

**MESH** wiki

**History (biz) trip**

**Wireless - low power**

**Real challenge?**

**IQMESH** approach

- **Czech Republic, EU**
- **found in 1991**
- **R&D, engineering, sales**
- **Almost 30 patents**
- **R&D team has over 20 people**

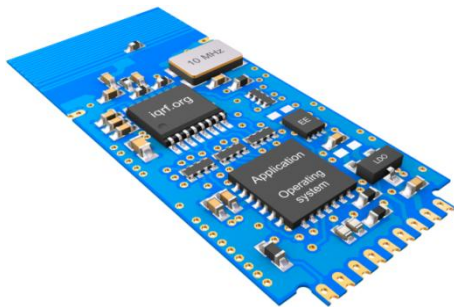

**IQRF platform**



**IQVCP platform**



**IQRF Smart House platform**

- **Technical university found in 1899**
- **The first university in Moravia**



**There are 12 departments at the Faculty, with about 190 teachers, 360 Ph.D. students and more than 4,000 students in Bachelor's and Master's study programmes. The quality of teaching is guaranteed by accreditation procedures, one at the national level by the Czech Ministry of Education, another by the European Association for Education FEANI.**

**MICRORISC and BUT started their fruitful cooperation in 2006.**

**Introduction**

**MESH wiki**

**History (biz) trip**

**Wireless - low power**

**Real challenge?**

**IQMESH approach**





*picture from official website: [www.side-line.com/](http://www.side-line.com/)*



*picture from official website: [www.side-line.com/](http://www.side-line.com/)*



**16 MESH = 1 mm**

**32 MESH = 0.5 mm**

# Partition of interval

$$a = x_0 < x_1 < x_2 < \dots < x_n = b$$

## ***The mesh of the partition***

$$x_0 < x_1 < x_2 < \dots < x_n$$

***is the length of the longest subinterval***

# **MeSH**

## **Medical Subject Heading**

**a vocabulary for the purpose of indexing articles  
and books in the life sciences**

# **MESH – Methanethiol ( $\text{CH}_3\text{SH}$ )**

**a colorless smelly gas**



# **MESH CIPHER**

## **(based on IDEA)**

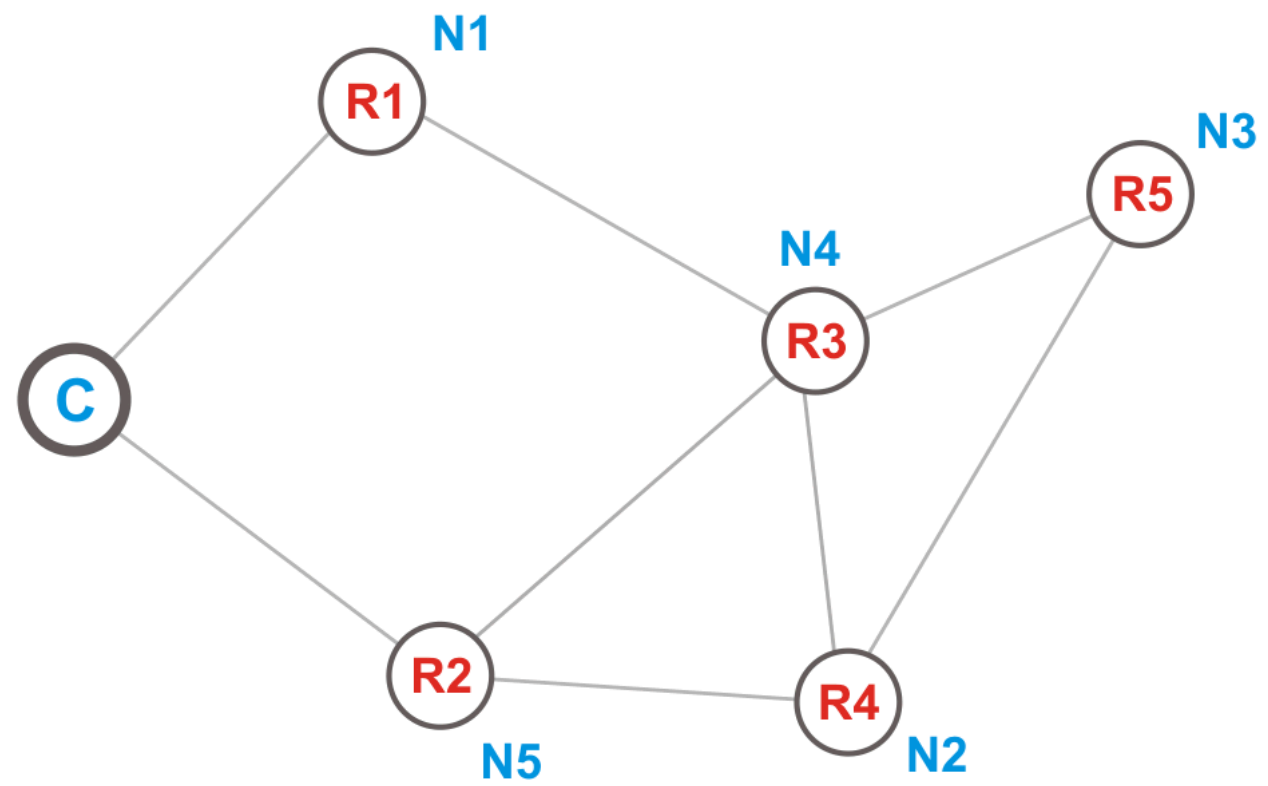

**Introduction**

**MESH wiki**

**History (biz) trip**

**Wireless - low power**

**Real challenge?**

**IQMESH approach**



**a word**

**(nobody took care about)**

# **a strange word**

**(used by FAE)**

# **a nice word**

## **(used by FSE)**

# **a magic word**

**(used by sales people)**

**Introduction**

**MESH wiki**

**History trip**

**Wireless - low power**

**Real challenge?**

**IQMESH approach**

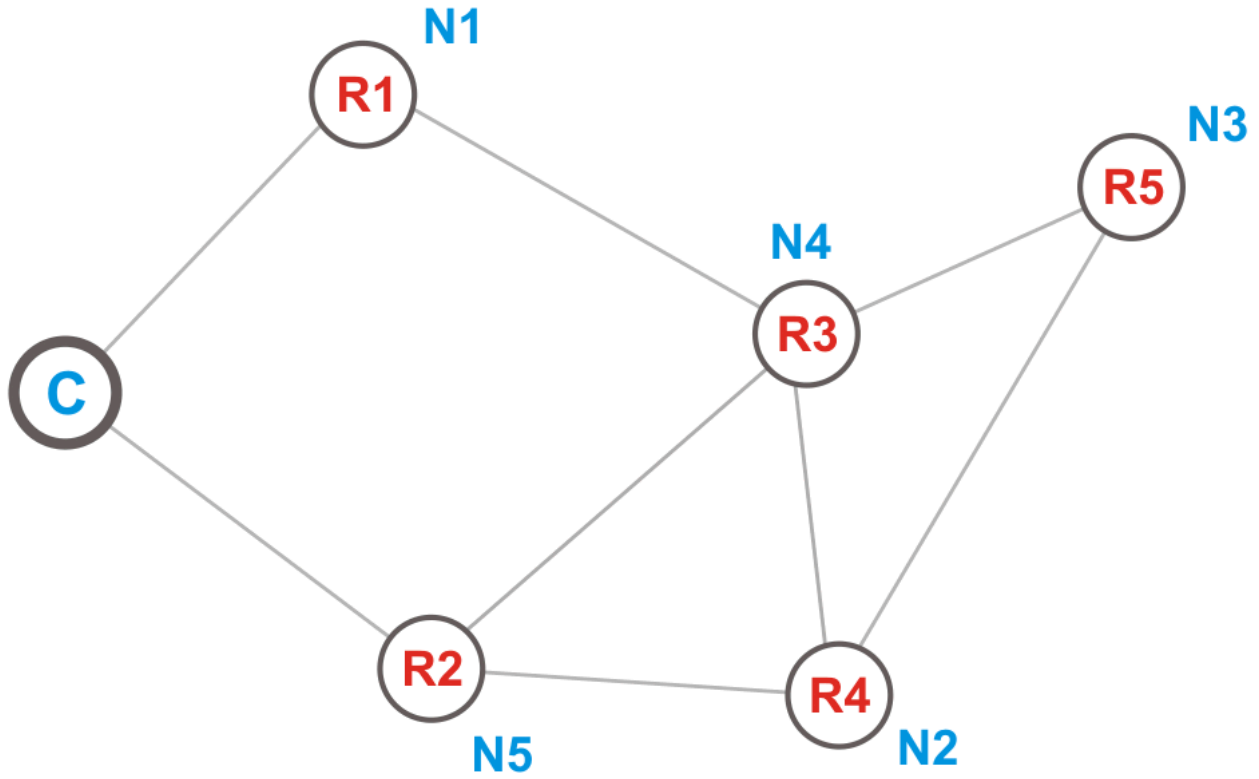

**Telemetry**



**Industrial automation**

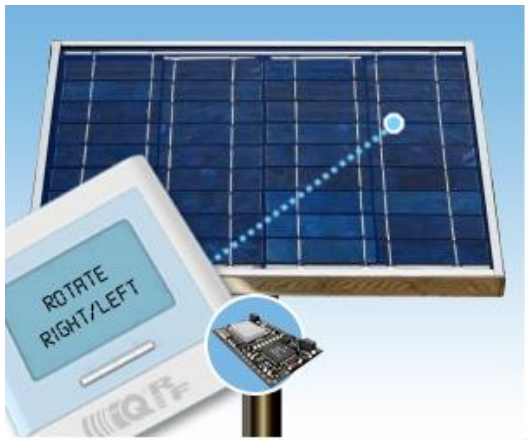

**Short range  
WIRELESS  
NETWORKS  
applications**

**Building automation**

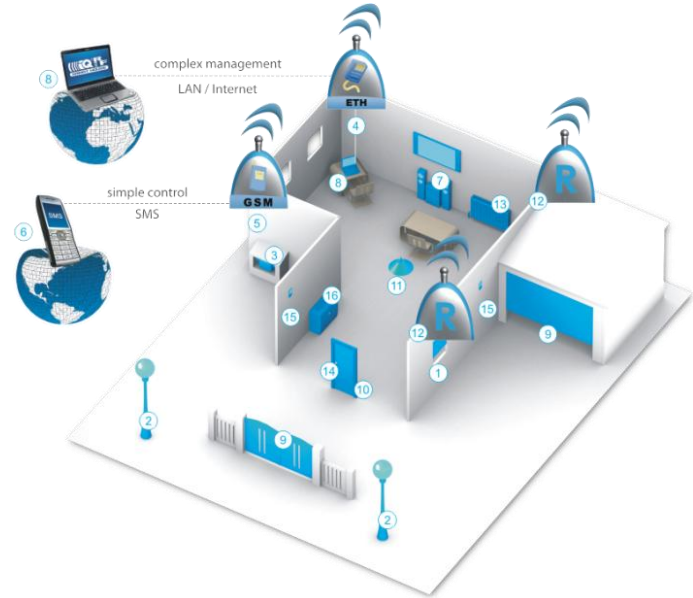

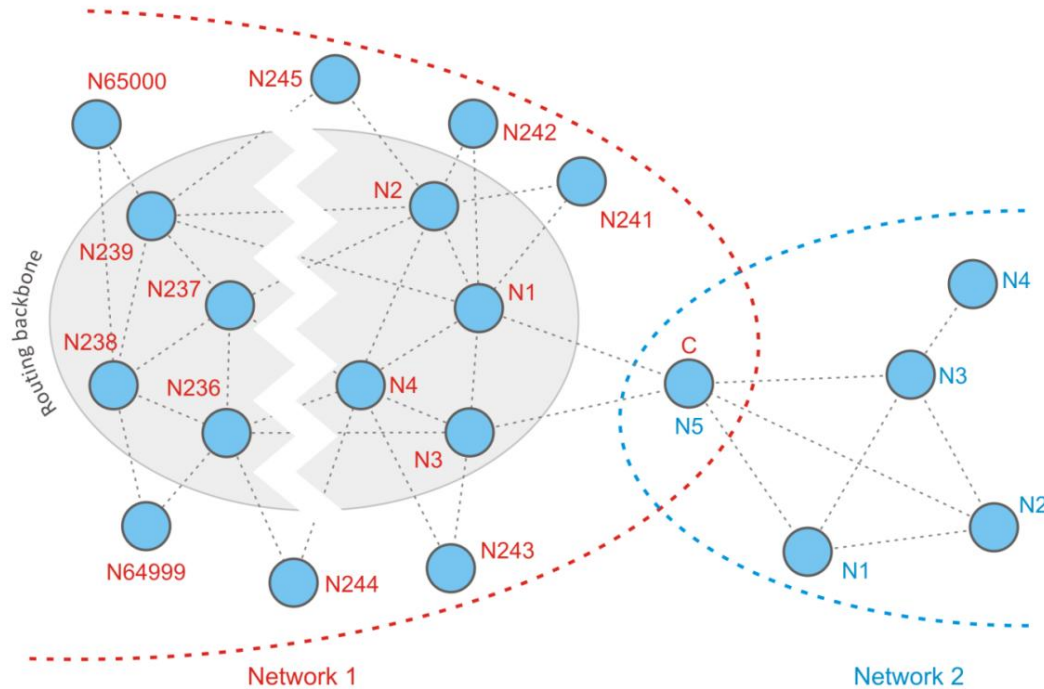

**thousands of devices**

**flexible timing**

**hundreds hops**

**concerns**

**ECONOMY**

**COMPLEXITY**

**RELIABILITY**

**(RT) PREDICTABILITY**

***wide MESH networks***

***... where reliability and determinism is a must***



**Introduction**

**MESH wiki**

**History trip**

**Wireless - low power**

**Real challenge?**

**IQMESH approach**

**ECONOMY**

**POWER CONSUMPTION**

**VARIETY OF DIFFERENT DEMANDS**

**LOW RATE COMMUNICATION**

**PREDICTABILITY & DETERMINISM**

**CONCURENCY AND INTERFERENCE**

**SPECTRUM SHARING**

# **A MESH FAIRY TALE ends**

**... reality is coming**

**THEORY OF GRAPHS**

**IN REAL TIME**

**IN SHARED SPECTRUM**

**WITH LIMITED RESOURCES**

## Number of links

$$N_{MAX} = \frac{n(n-1)}{2}$$

**Packet can “travel” over the network  
by many different ways.**

**Should network specify the best one(s)?**

**How? When?**

## **ECONOMY & POWER CONSUMPTION**

**Great algorithms**  
“battery eaters”  
resources demanding

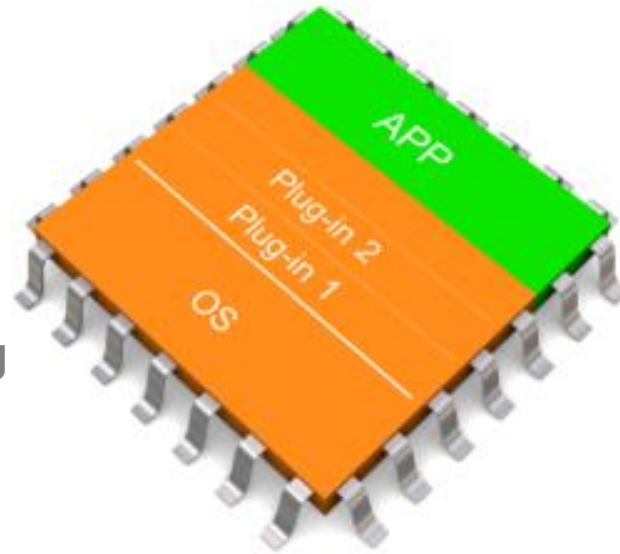

“lower resources”  
**0.50 USD vs. 50 USD**  
“higher consumption”

## POWER CONSUMPTION & RT

**Centralized management?**

**Distributed services?**

**Acknowledgements?**

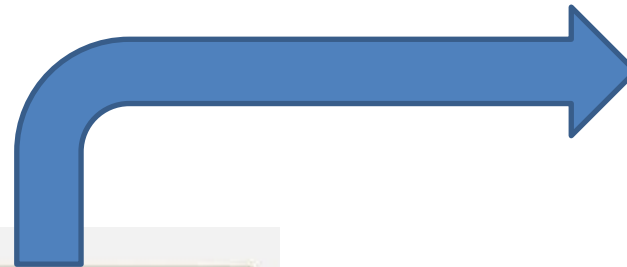

**Introduction**

**MESH wiki**

**History trip**

**Wireless - low power**

**Real challenge?**

**IQMESH approach**



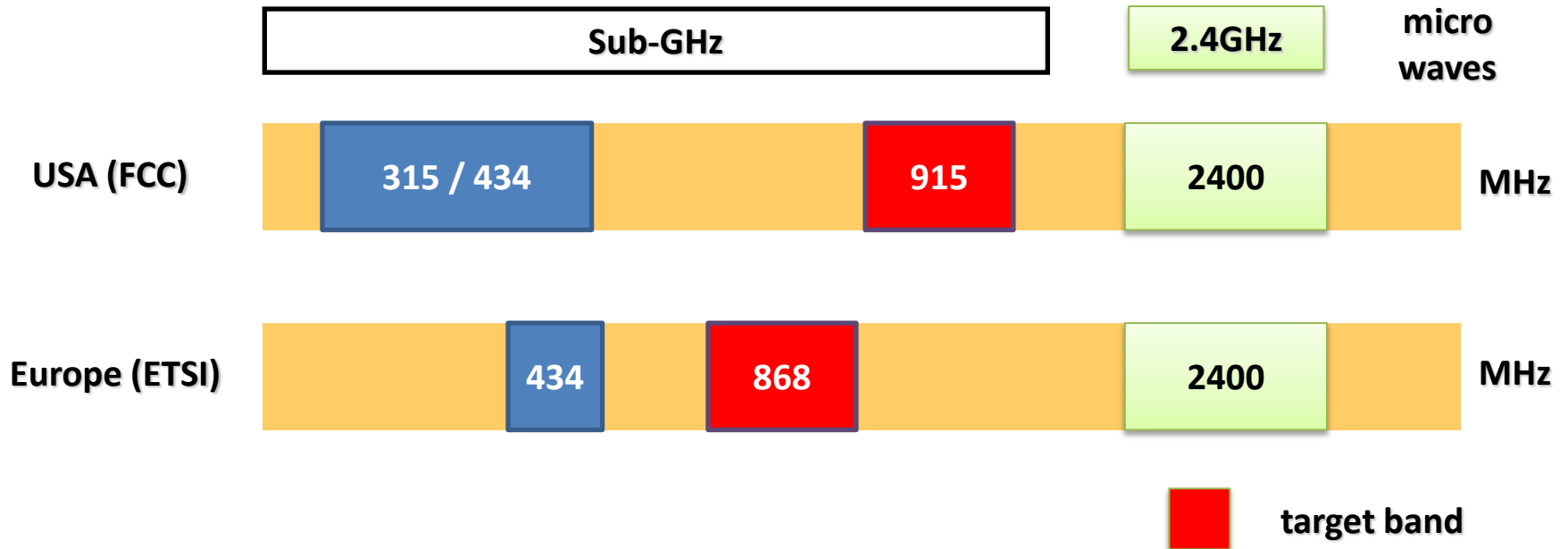

***IQRF can work at any band***  
***specializes to sub-GHz ISM bands***



**Point-to-Point**

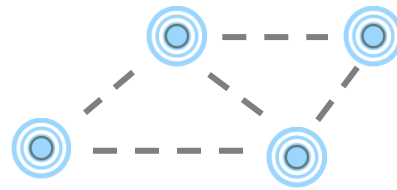

**Point-to-Multipoint**

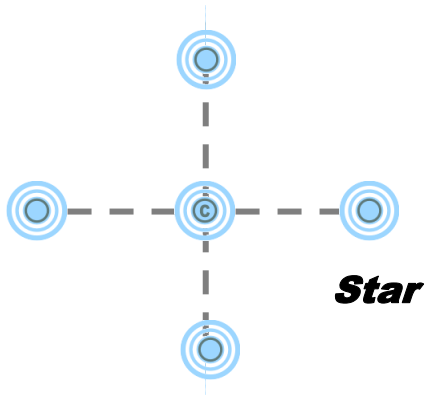

**Star**

**FACTS**

**No routing**

**No Discovery**

**240 devices**

**Fixed addressing**



**For smaller applications – home automation, small networks**

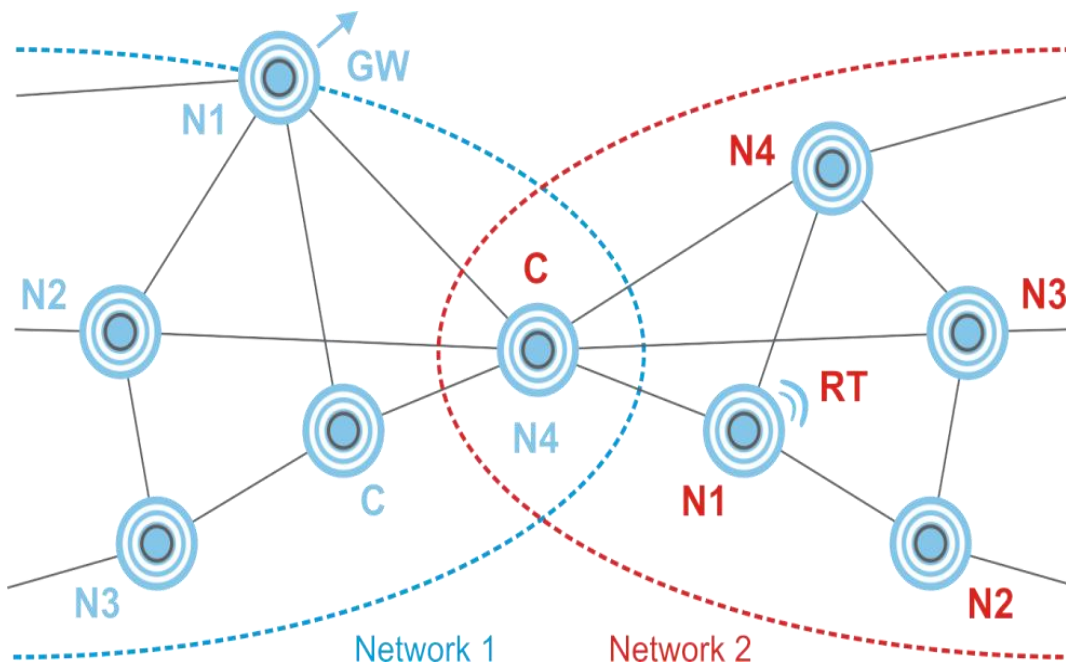

- FACTS**
- 240 hops**
  - No Discovery**
  - Fixed timing**
  - Fixed routing**
  - 240 devices**
  - Fixed addressing**
  - Networks chaining**

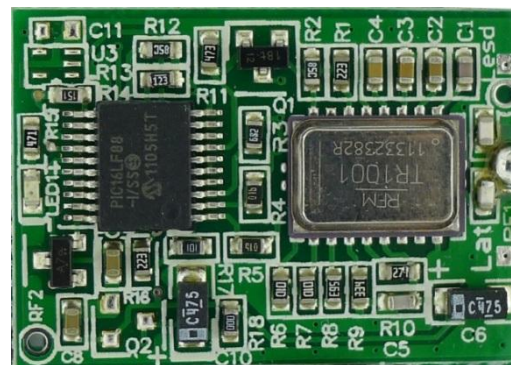
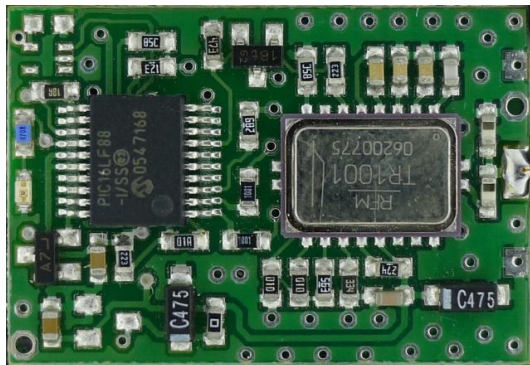

**For smaller applications – home automation, small networks**

**Source routing**

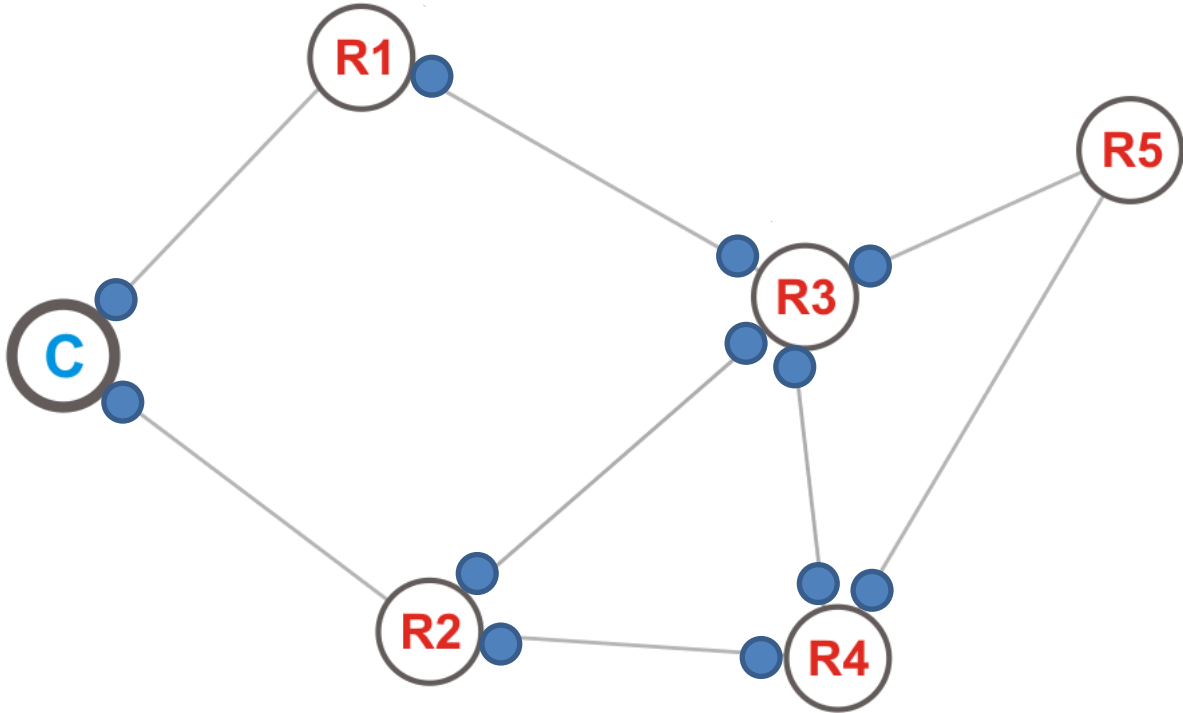

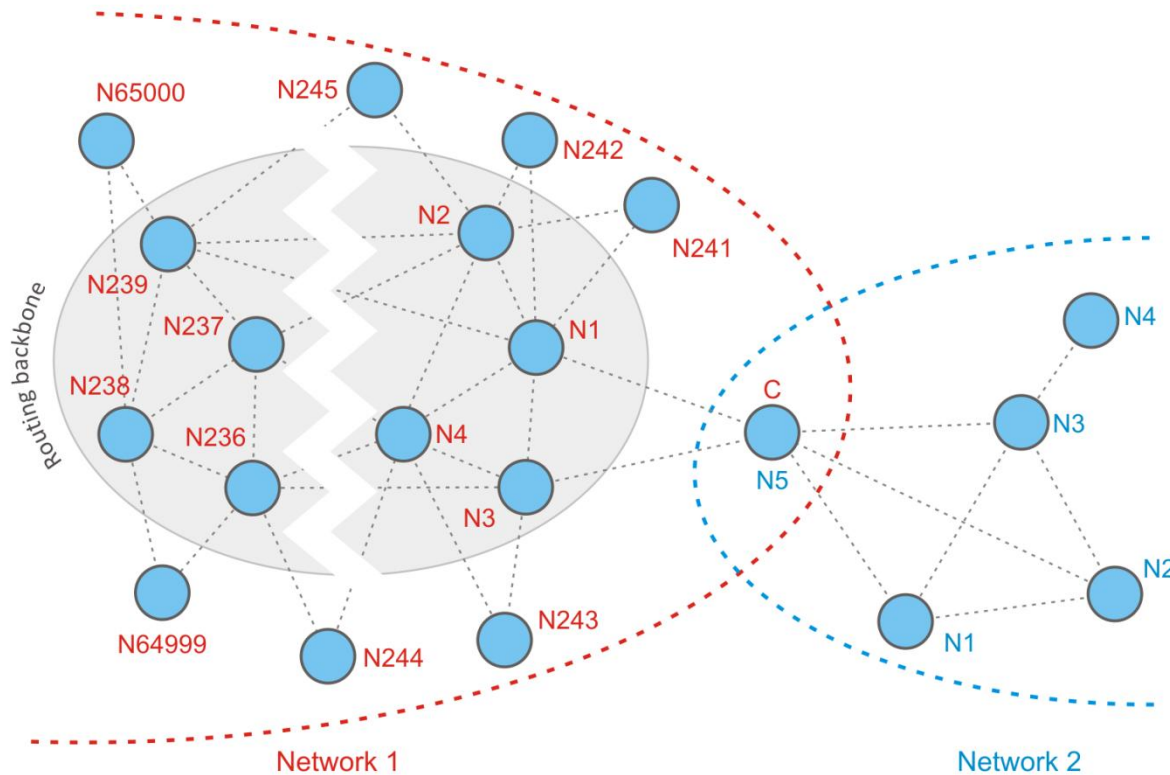

- FACTS**
- 240 hops**
- Discovery**
- Flexible timing**
- Flexible routing**
- 65 000 devices**
- User's addressing**
- Networks chaining**
- ICWP™**

**For applications where extra low consumption and flexible routing is requested**

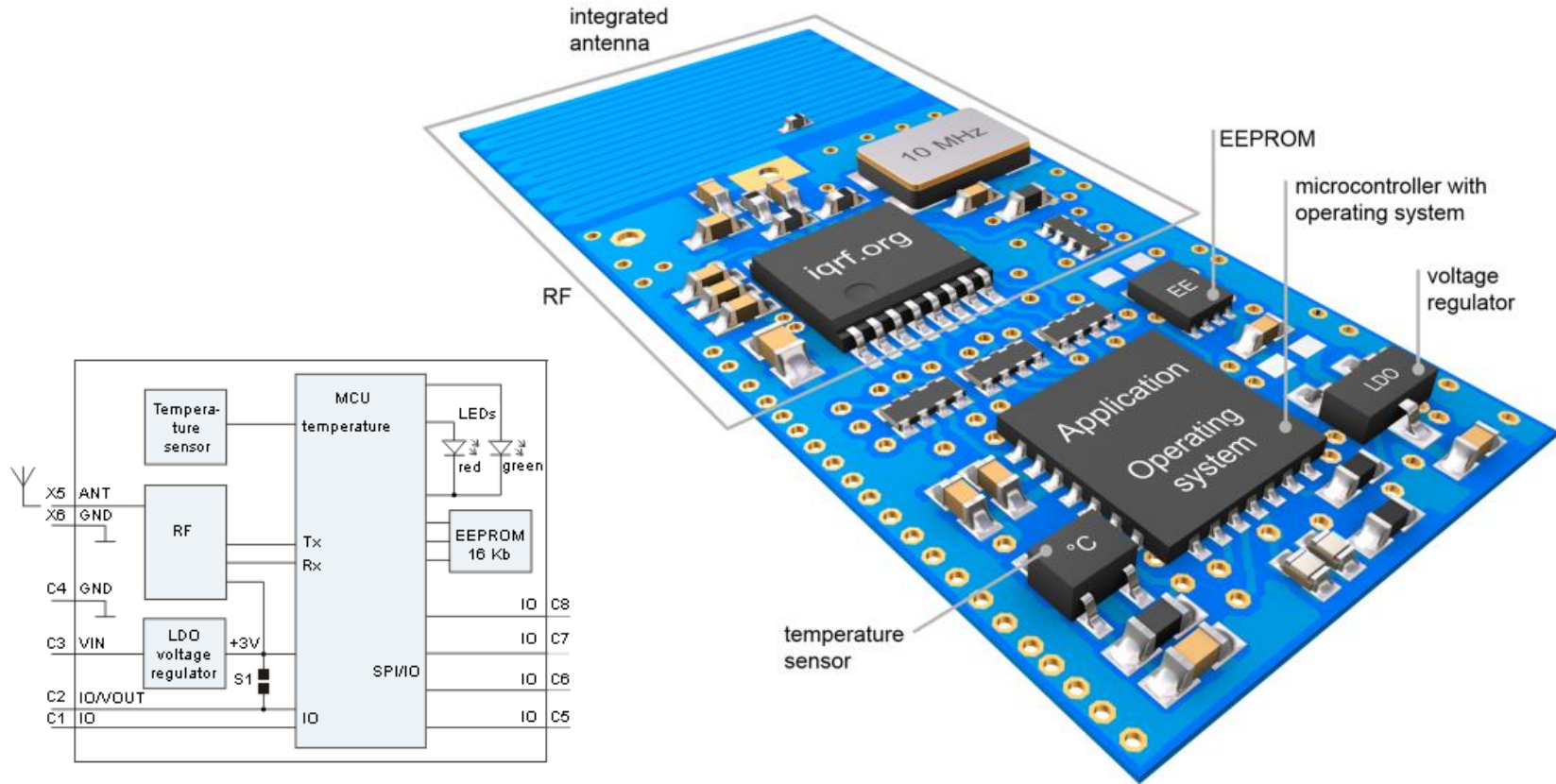

**TR-52BA modules ... 600 m @ 3.2 mW**

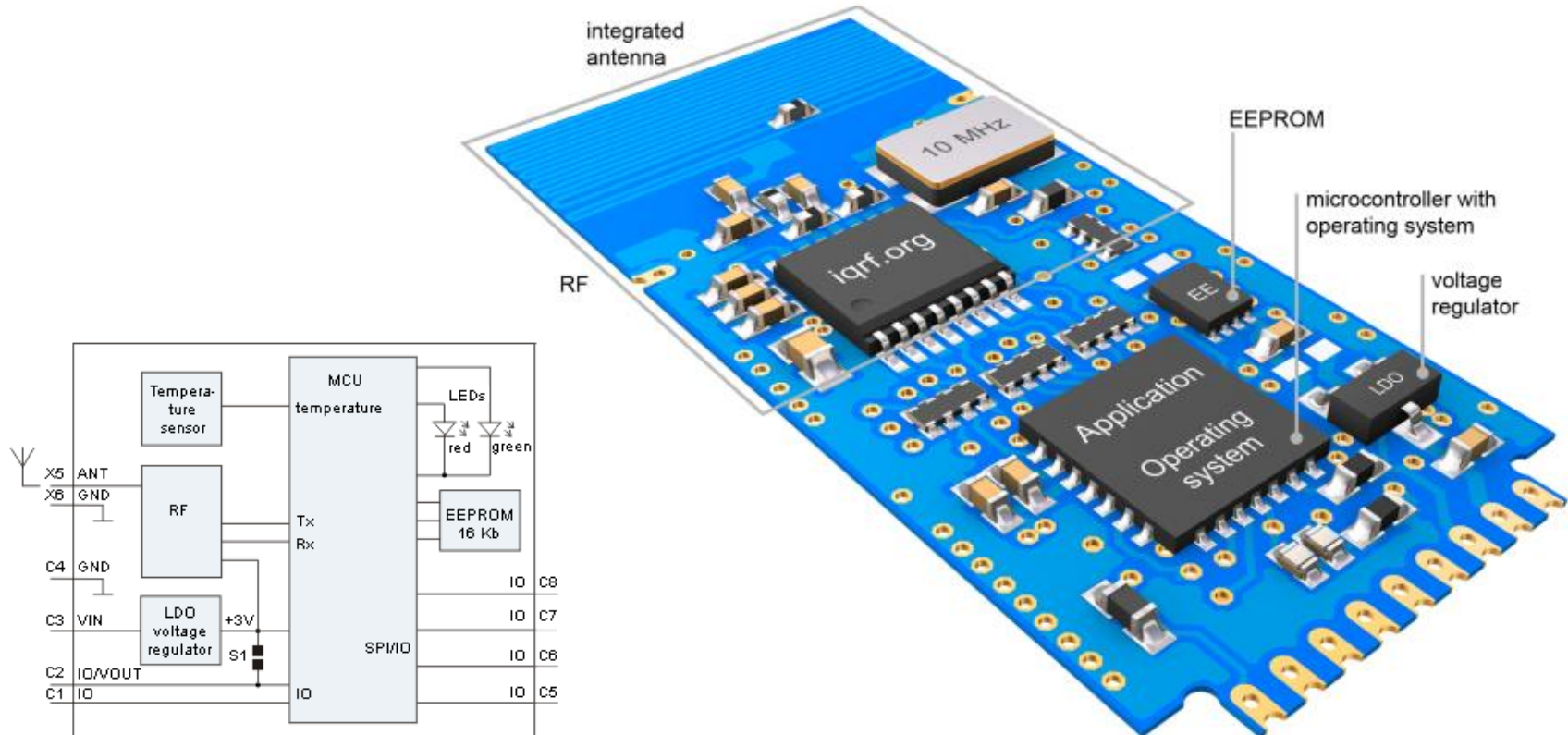

**TR-53BA modules ... new built-in options, keeping SIM compatibility**

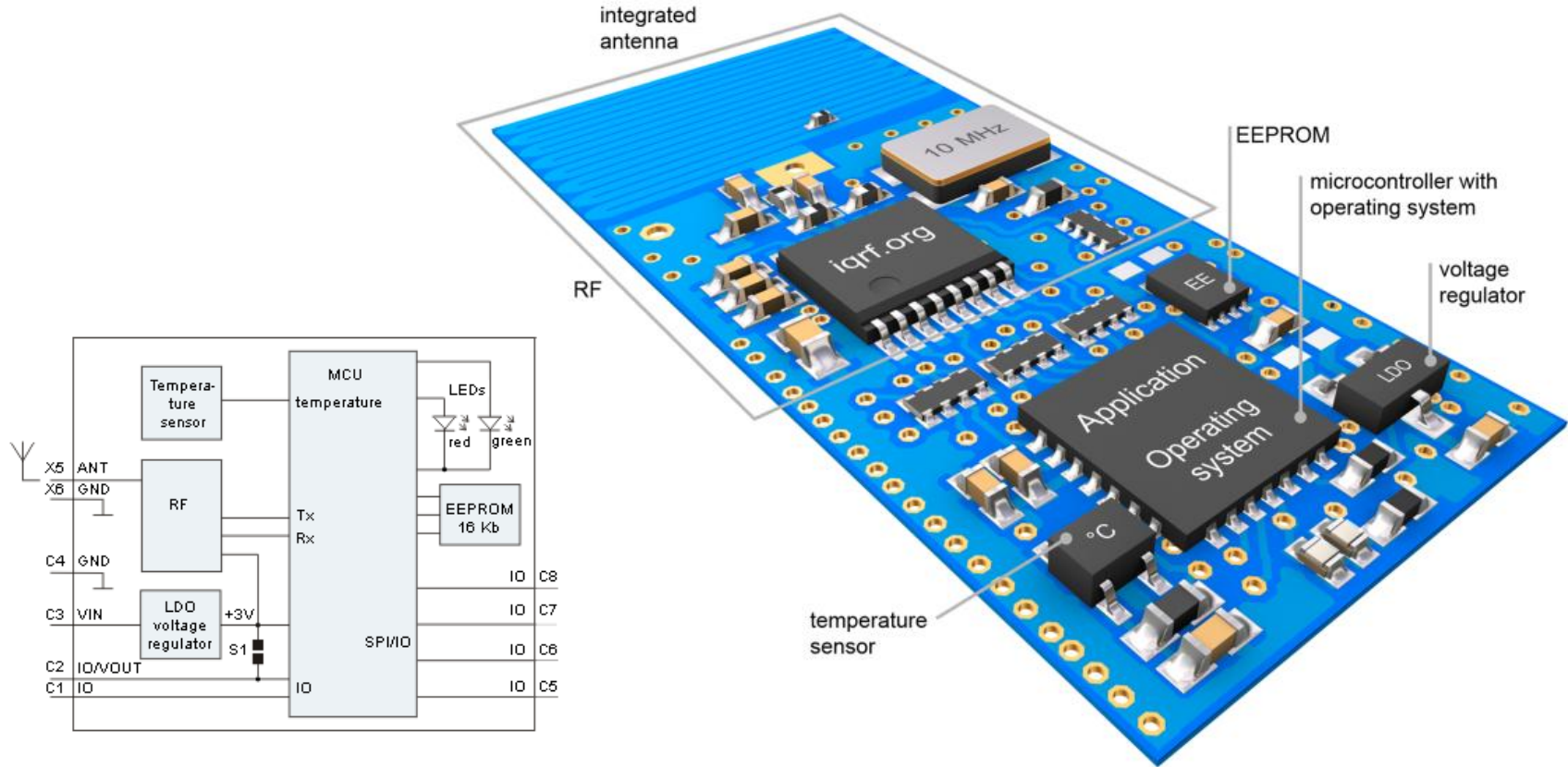

**TR-52DA modules ... more resources, seamless migration**



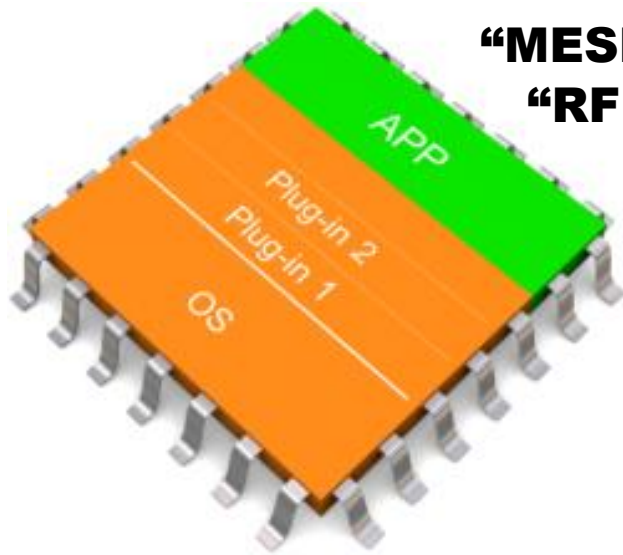

**“MESH included”**  
**“RF included”**

# TR-52BA

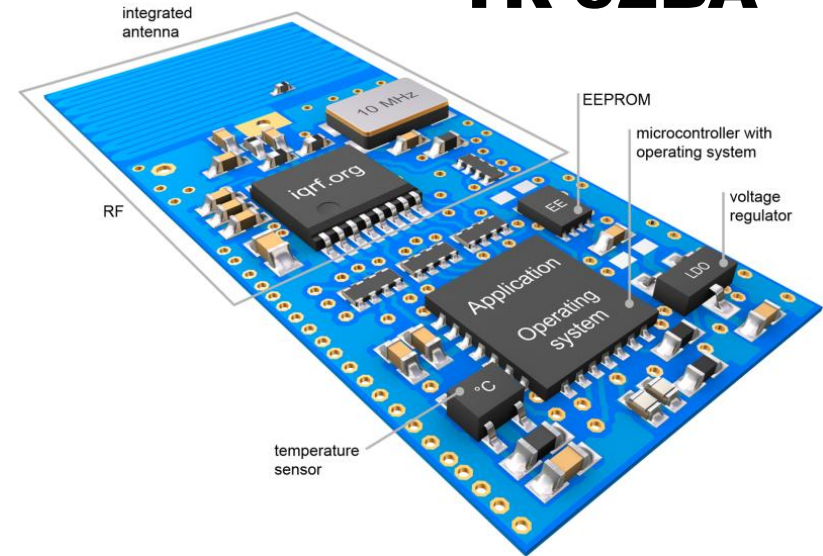

**>600 m @ 3.2 mW**

**35  $\mu$ A @ XLP RX**

**ICWP™**

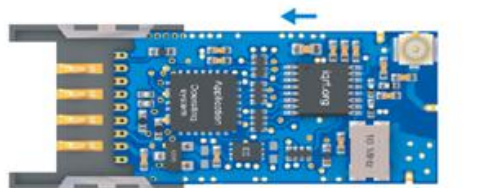

SIM connector

Fixation possible

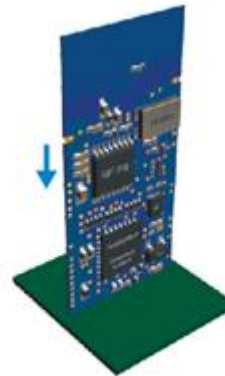

Through-slot soldering

***Smart Transceivers modules***  
***for Wireless Network Communication***

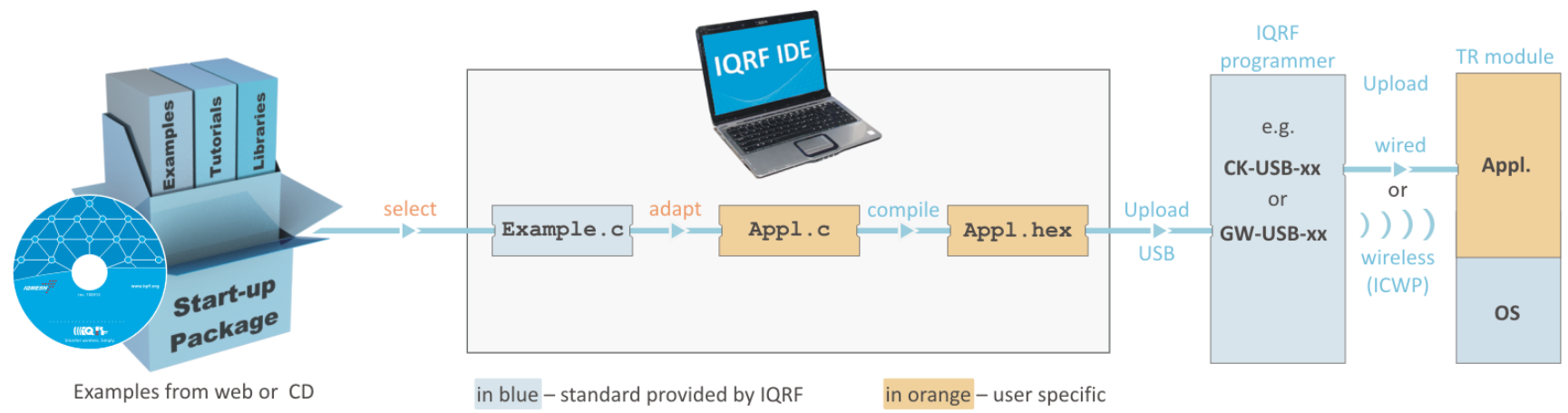
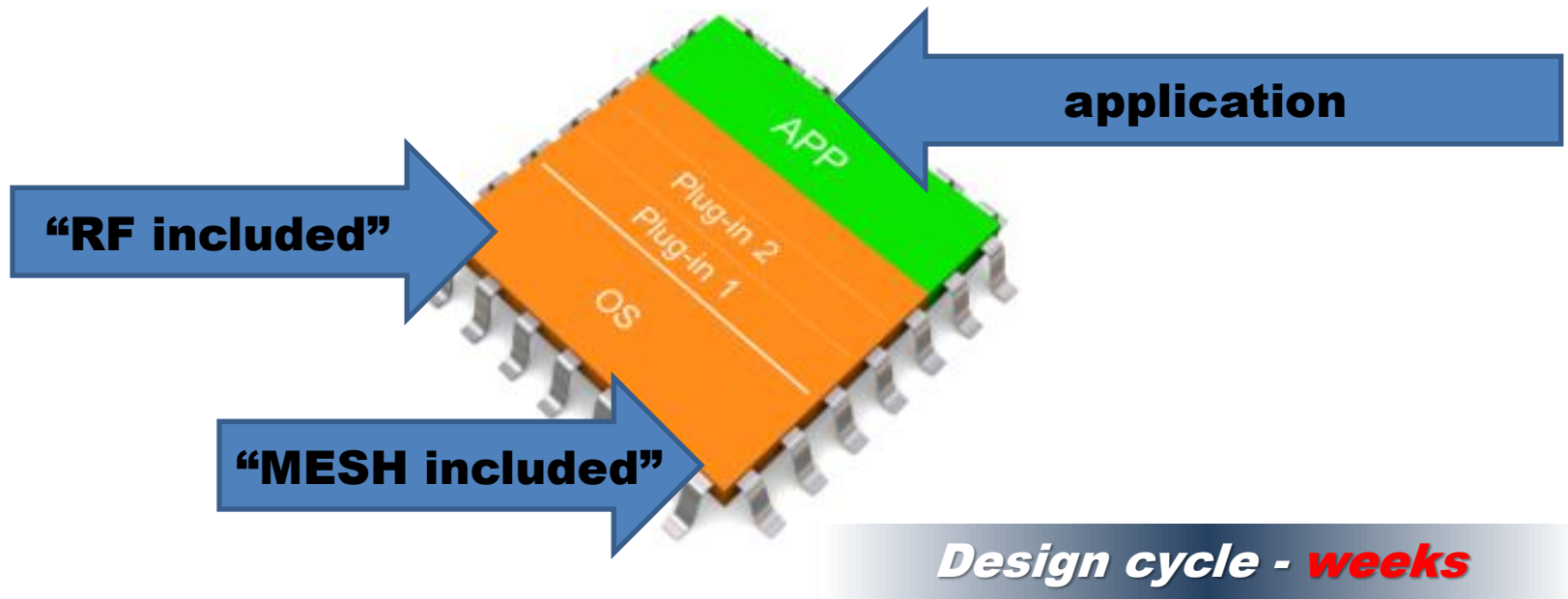

**no broken links**

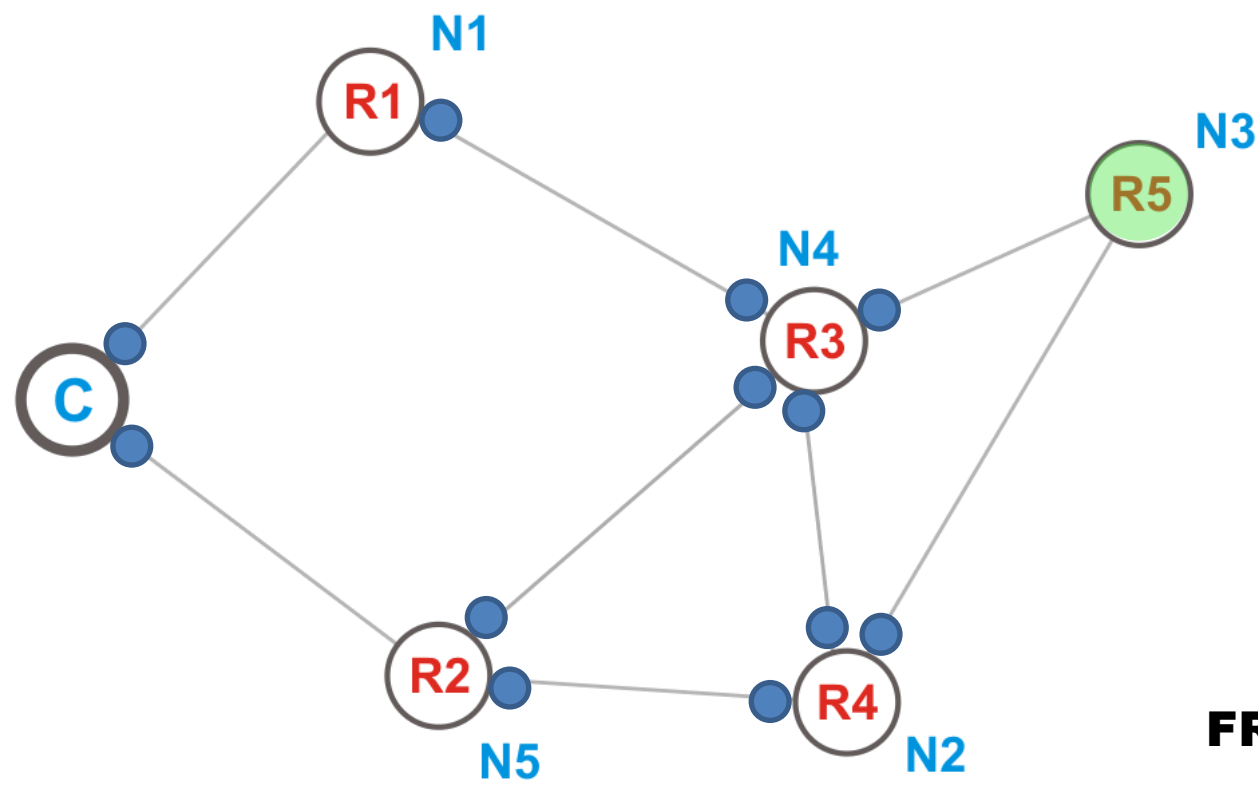

**⊘ 2 broken links**

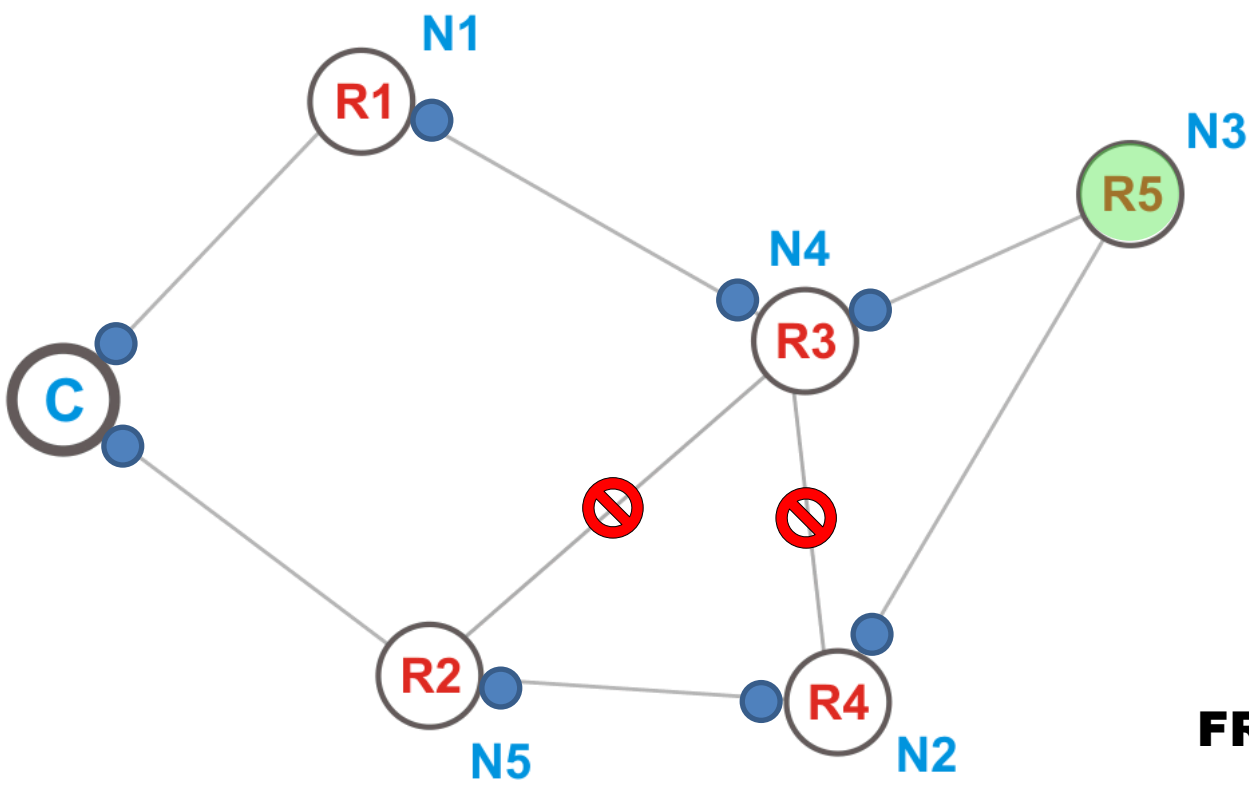

**FRAME**

0	1	2	3	4
---	---	---	---	---

  
Active time slot

**5 broken links**

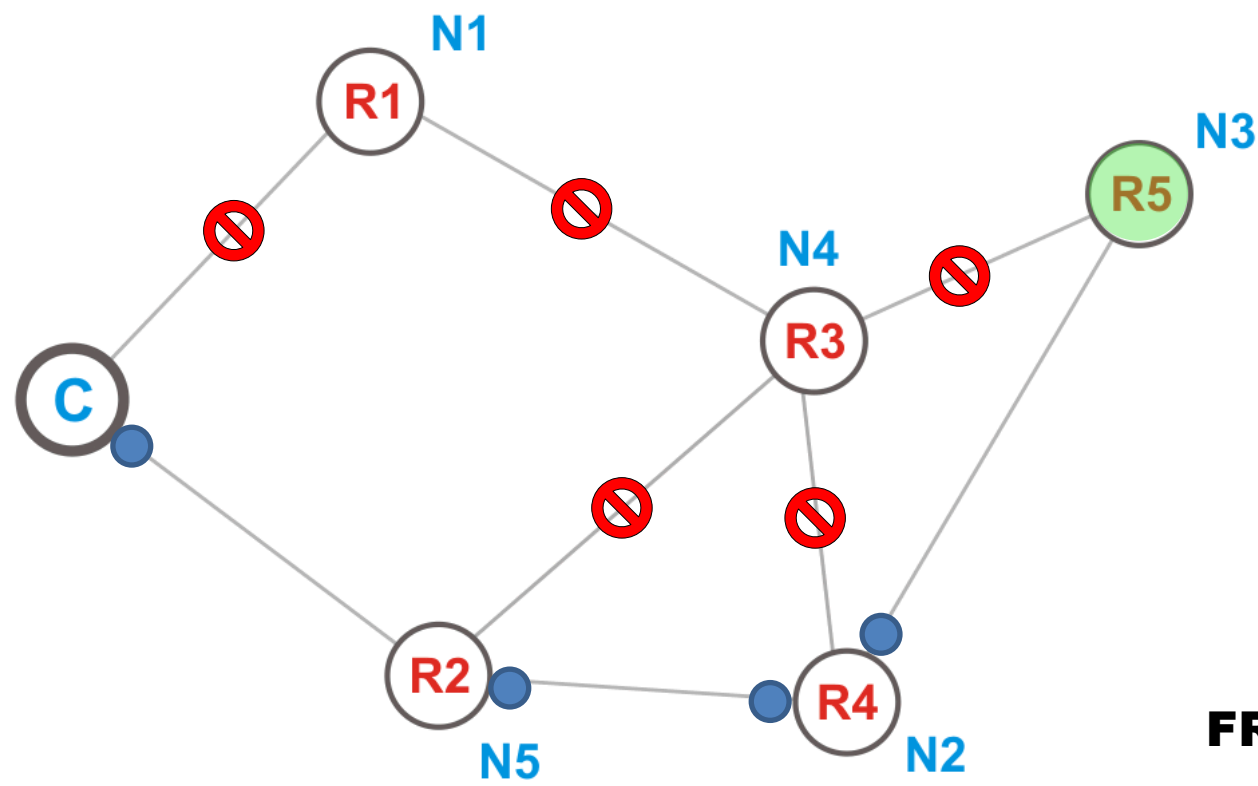

**FRAME**

0	1	2	3	4
---	---	---	---	---

  
Active time slot

 **no broken links**

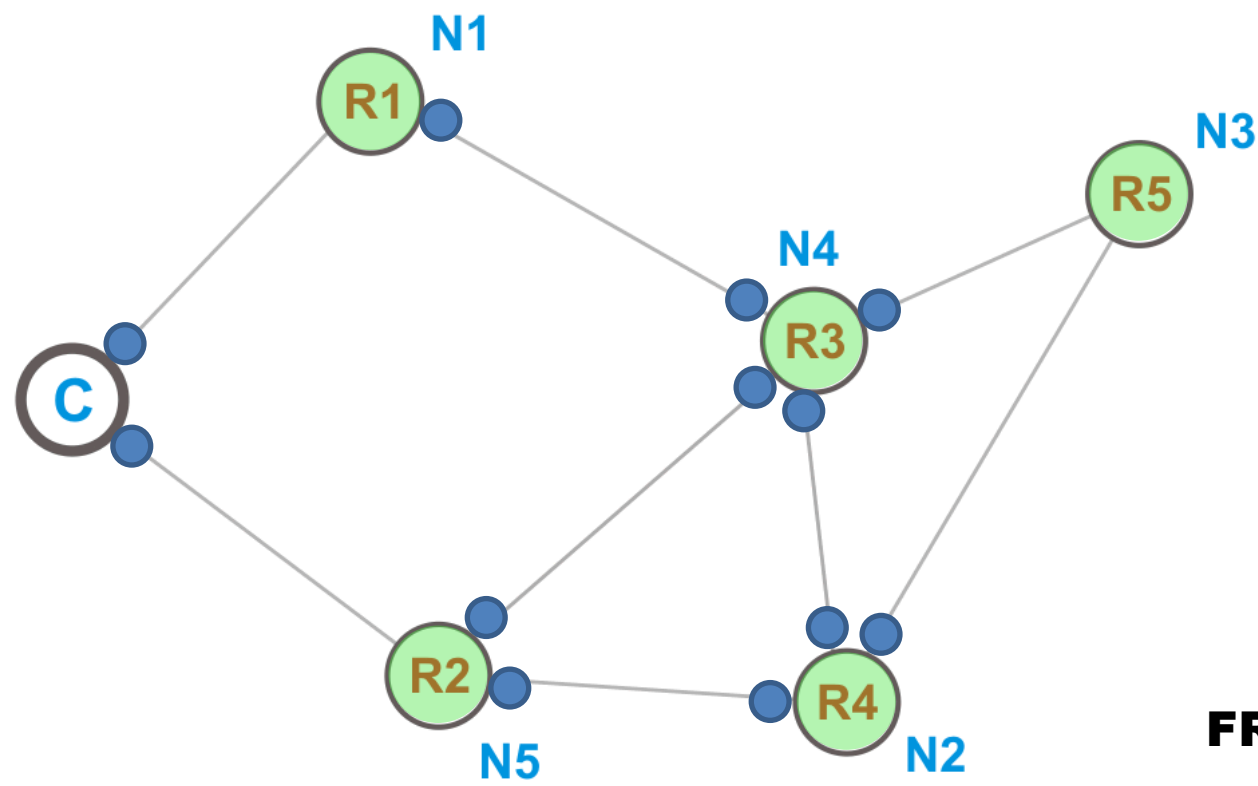

**FRAME**

0	1	2	3	4
---	---	---	---	---

  
Active time slot

**3 broken links**

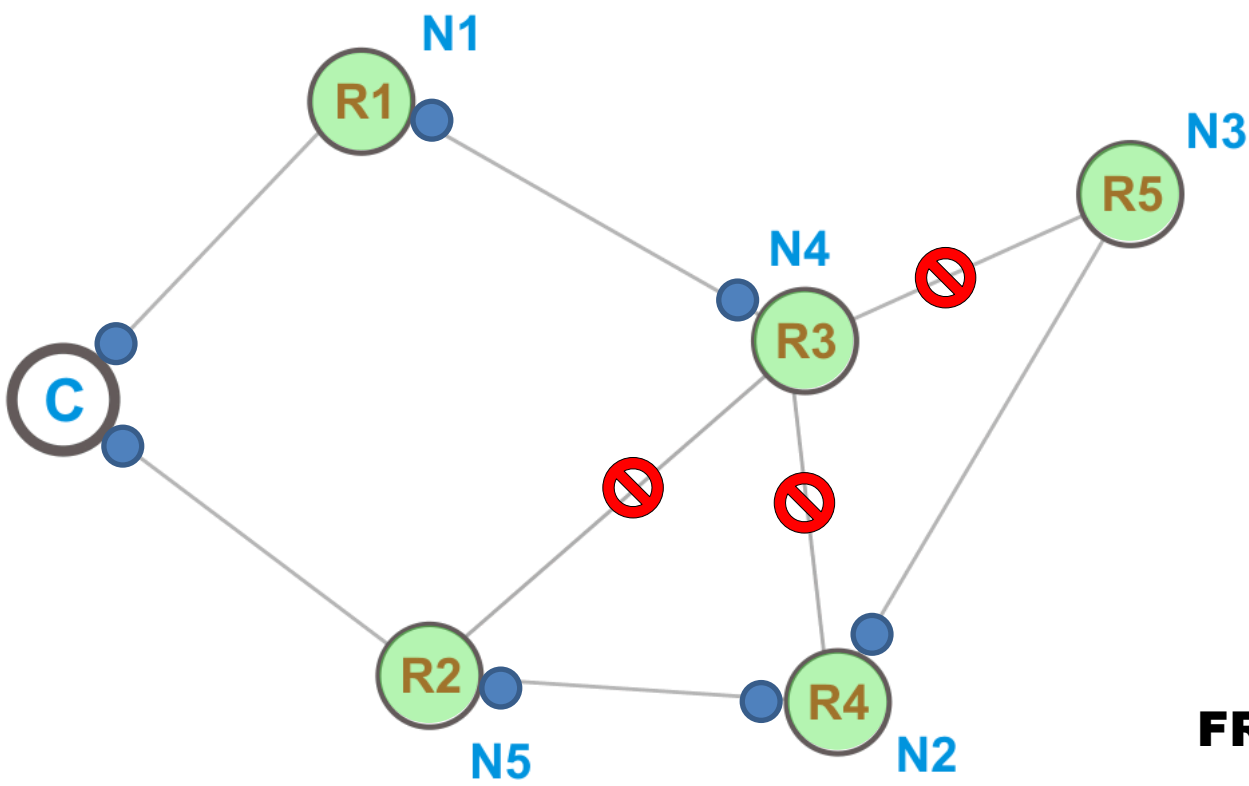

**FRAME**

0	1	2	3	4
---	---	---	---	---

  
Active time slot

**4 broken links**

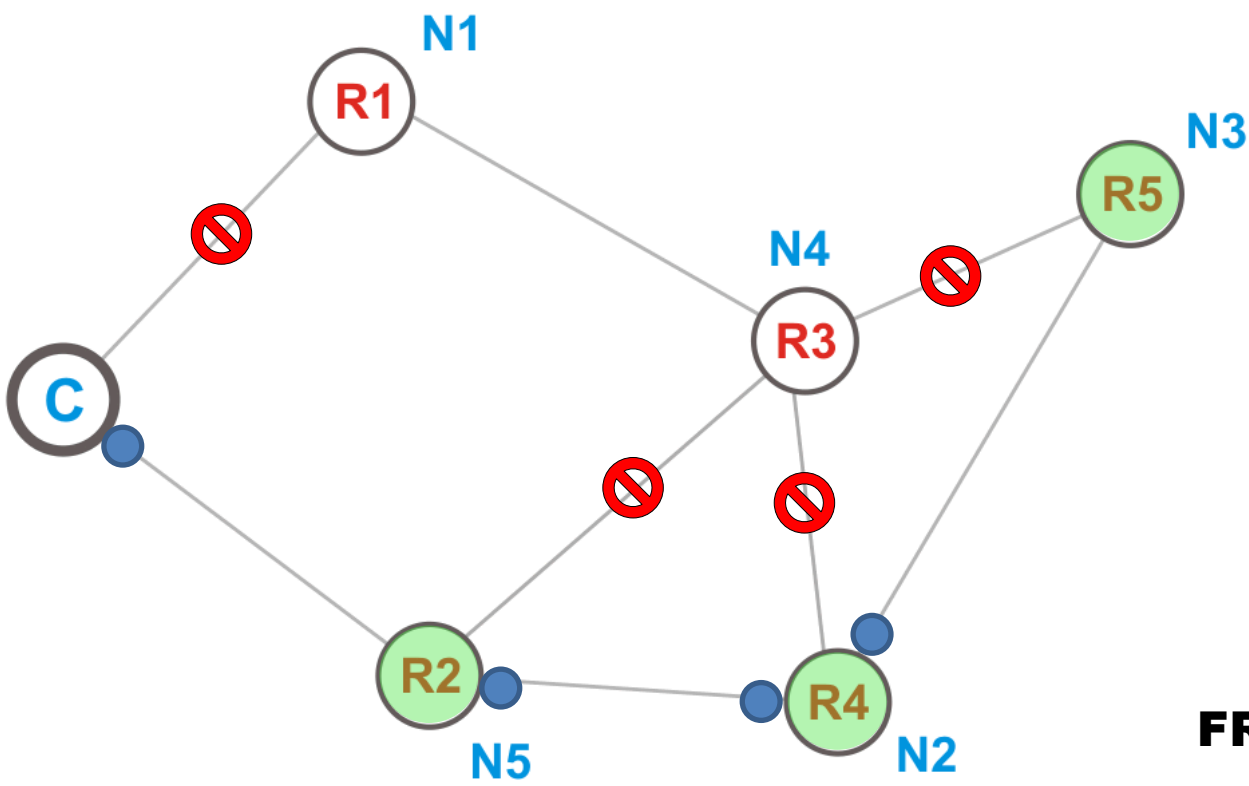

**FRAME**

0	1	2	3	4
---	---	---	---	---

  
Active time slot



## Routed network packet – maximum compatibility

### IQRF OS 2.1x

```
DLEN = 64;           // set packet length
_ROUTEF = 1;        // mesh topology
RX = 7;             // set recipient
RTDEF = 0;          // static route "4+1"
RTV0 = 1;           // set routing vector
RTV1 = 2;           //      ||
RTV2 = 3;           //      ||
RTV3 = 4;           //      ||
RFTXpacket ();     // send packet
```

### IQRF OS 3.0x

```
DLEN = 64;           // set packet length
_ROUTEF = 1;        // mesh topology
RX = 7;             // set recipient
RTDEF = 1;          // SFM algorithm
RTDT0 = 4;          // 4 routes
RTDT1 = 5;          // set time slot
RFTXpacket ();     // send packet
```

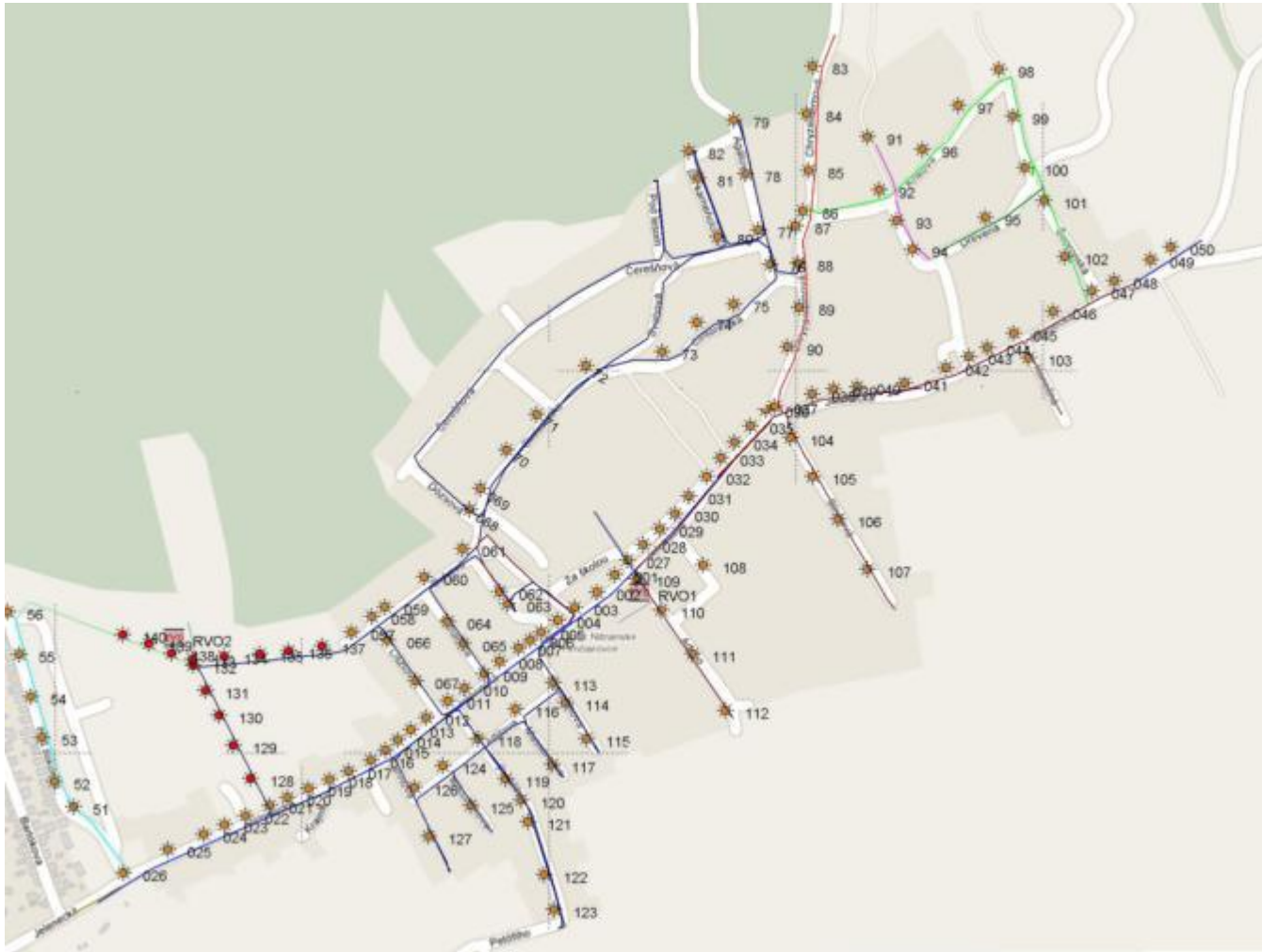

**IQMESH perfectly fits to street lighting applications**

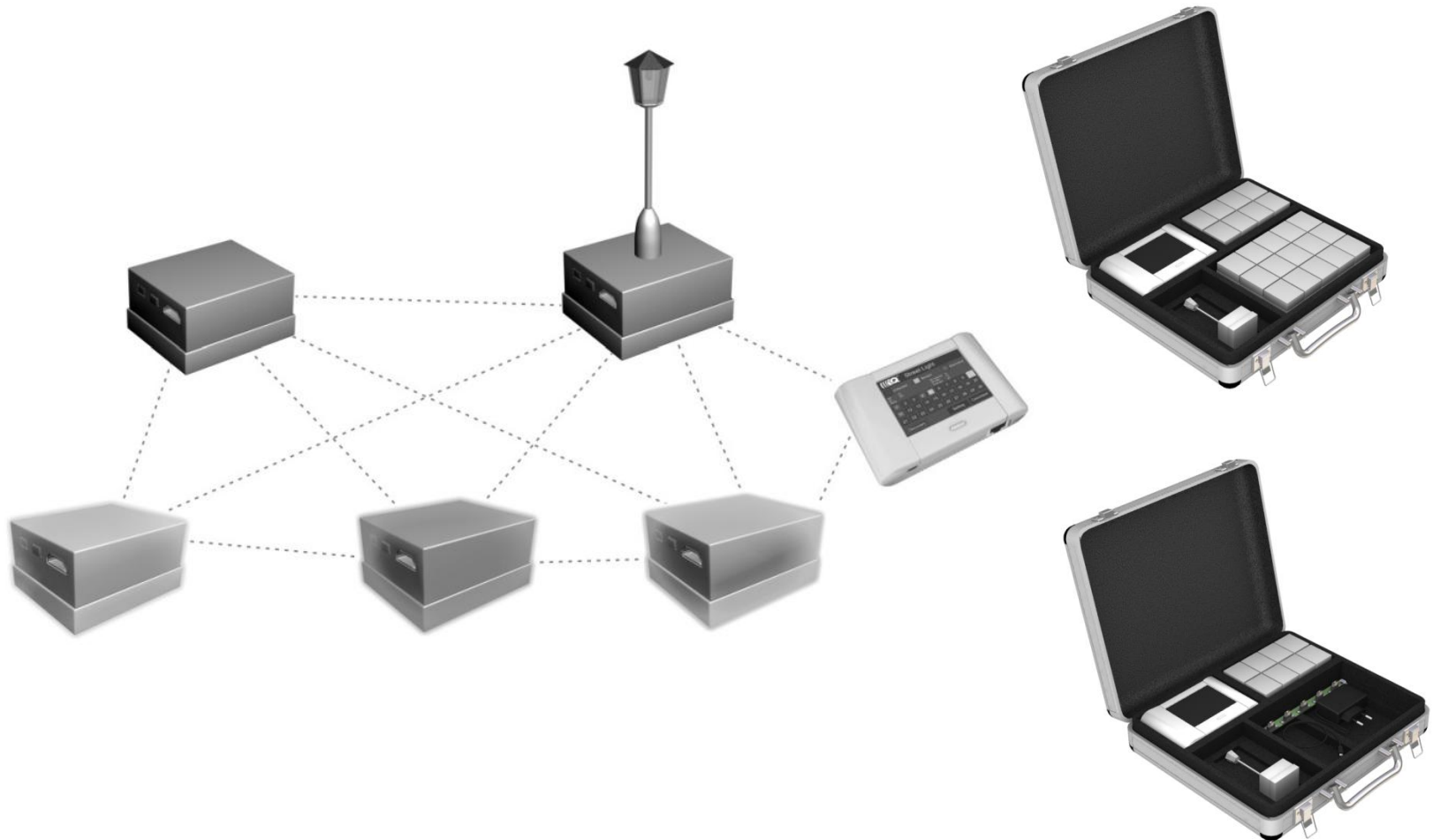

**RD-SL-01 ... presents specific tasks in Street lighting**

Protocol	Nodes *	Routers *	Routers #	Hops *	Hops #
MiWi	1 024	7	7	4	4
Zigbee	65 536	65 536	20	Infinite	6
Zigbee Pro	65 536	65 536	50	Infinite	10
IQMESH	65 000	240	240	240	240

\* ideal value (MCHP)

# practical value (MCHP)

***Practical value means 'in real life'***  
***... reality disqualifies some systems for some apps.***

Platform	License fees	Open	IP	Complexity
MiWi	No	Yes	No	Low
Zigbee	Yes	No	Routing	High
Zigbee Pro	Yes	No	Routing +	Very high
IQRF	No	Yes	Realization +	Low

***Higher complexity results to higher costs***  
***... and longer time-to-market***

# **A MESH FAIRY TALE?**

**... MESH ... MESH ... MESH**

**... FUNNY WORLD OF BUSINESS**

**... MESH MANAGEMENT is a CHALLENGE**

**... EFFICIENT ORIENTED FLOODING**

# **A MESH FAIRY TALE?**

**IQMESH CAN HELP IN/TO WMN**

**IQMESH WILL BE FULLY OPEN**

**Special thanks** to the Ministry of Industry and Trade of Czech Republic, co-financing our projects “IQRF Smart House platform” and “Open Platform for Smart Cities”, making our projects feasible.

*Thank you for your  
patience!*



***Smarter wireless. Simply.***